

ITEM	Part Config	DESCRIPTION	Config	QTY.	Weight
1	MMB-0812	8'x12' Medium Duty Panel	MM 8X12	2	2325
2	MMB-1012	10'x12' Medium Duty Panel	MM 10X12	2	2740
3	AMB22-4	4-Foot Corner Connector	4 PIN	4	200
4	AMB22-6	6-Foot Corner Connectors	6 PIN	4	330

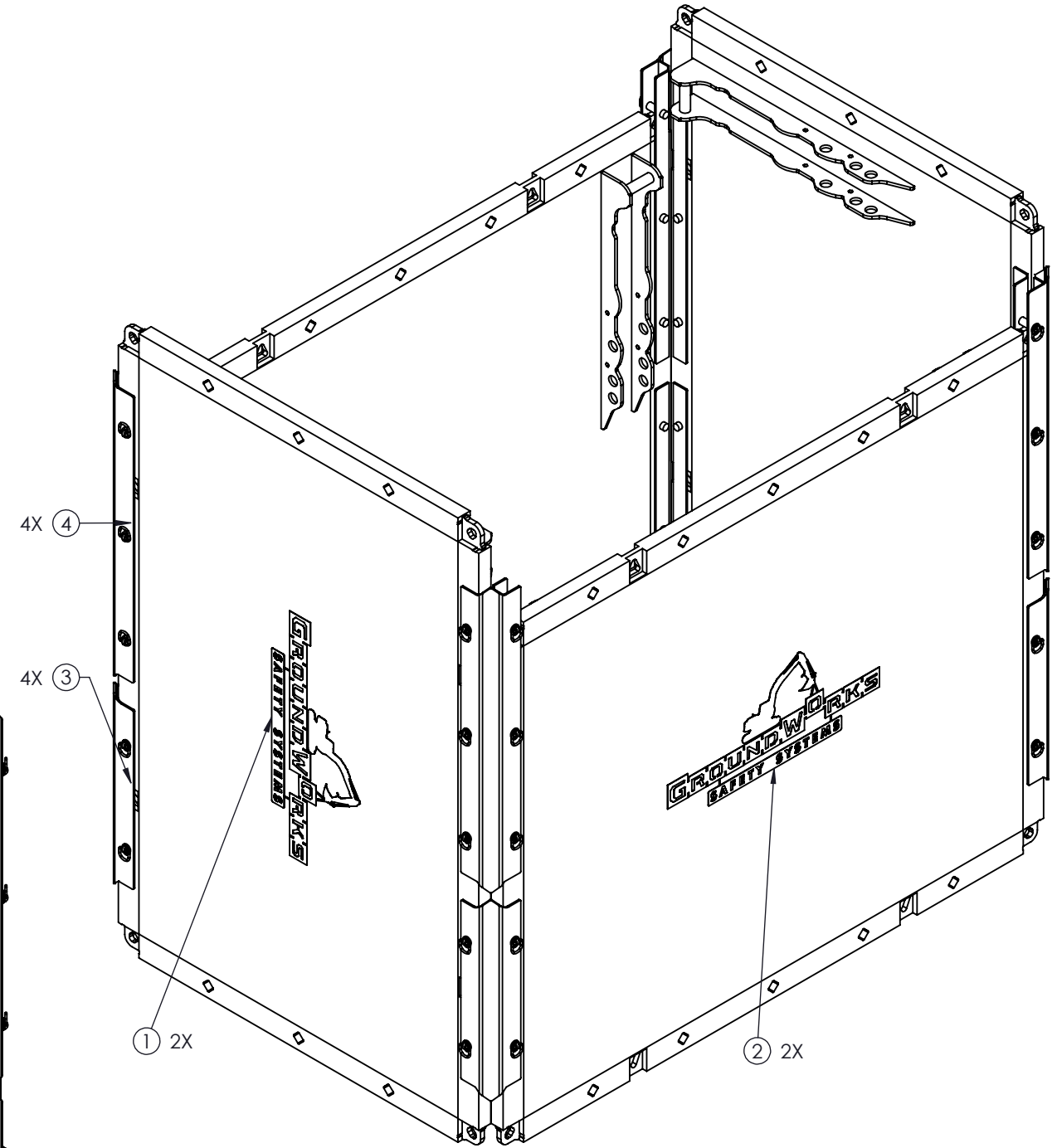
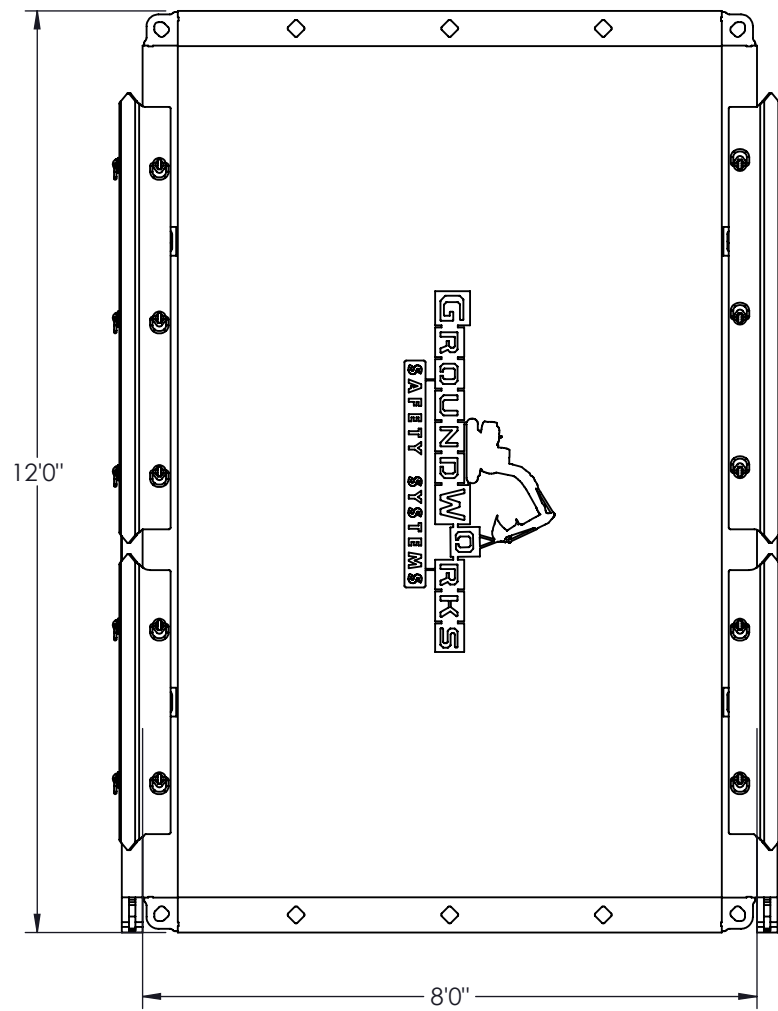
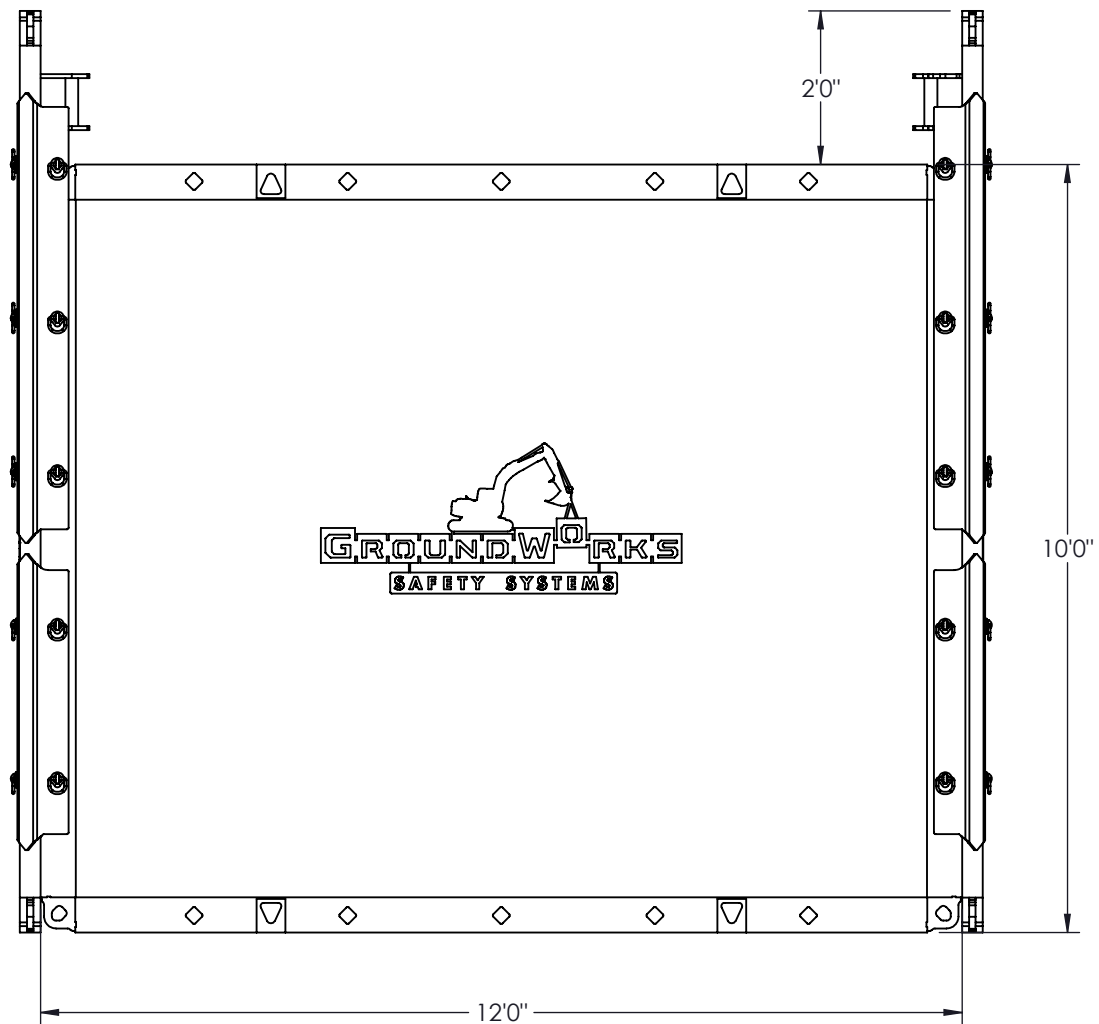
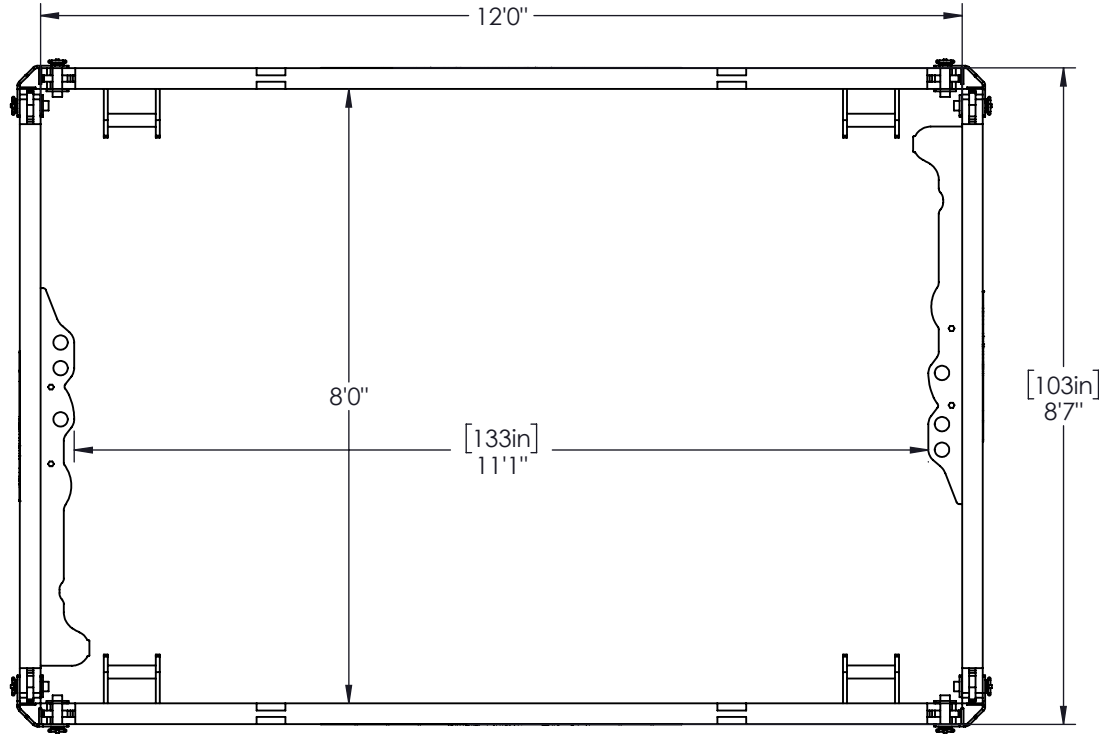

NOTICE OF CONFIDENTIALITY:
 INFORMATION INCLUDED IN THIS DRAWING
 IS PROPRIETARY, AND IS NOT TO BE
 REPRODUCED, DISTRIBUTED, OR DISCLOSED
 EXCEPT AS SPECIALLY AUTHORIZED IN
 WRITING BY GROUNDWORKS SAFETY
 SYSTEMS, INC.

SCALE: 1:30
 DATE: 2025-12-04
 WEIGHT: 12250 lbs

4207 53rd Street Close, Innisfail,
 Alberta, T4G 1P9

DWG TITLE:
 MM 10X12 12LX8WX10D_4S